



CUSTOMER TRUST AWARDS

Week of November 14th

Sponsored by



[Fixed Ops Insight](#) is *the* place for service, parts and collision information.

[OilReset](#) provides free maintenance light reset information for repair facilities.

[Women-Drivers](#) connects women and families with *Certified Women-Drivers Friendly™* car dealerships.

CUSTOMER TRUST AWARDS

Week of November 14th

ClearMechanic enables automotive service centers to take and share thousands of vehicle photos every week. Each vehicle photo represents an actual service recommendation to a customer.

The “Customer Trust Awards” recognize five vehicle photos that we judged most helpful in building trust in the automotive repair process. Our judgment is partly based on creativity and photo quality and partly based on number of consumer views, clicks and “shares” tracked by our technology platform.

For each winning vehicle photo, we have including the following information:

- **Repair type** being recommended
- **Dealership or repair shop** that took the photo and shared it using ClearMechanic technology.
- **Expert diagram** that ClearMechanic automatically features alongside our vehicle photos

GO TO NEXT PAGE TO VIEW WINNING PHOTOS!

Vehicle Photo #1: Brake Rotor

Tom Wood Lexus

Indianapolis, IN

http://www.tomwoodlexus.com/Service_Pictures

✕

Brake Rotor

YOUR CARILLUSTRATIONTEXTIMAGE



➔

share

⬅





(x) using a micrometer, measure
Standard thickness:
28.0 mm (1.102 in.)
Minimum thickness:
25.0 mm (0.984 in.)

(x) using a micrometer, measure
Standard thickness:
28.0 mm (1.102 in.)
Minimum thickness:
25.0 mm (0.984 in.)

➔





Brake Rotor

YOUR CAR ILLUSTRATION TEXT IMAGE

(a) Using a micrometer, measure

Standard thickness:
28.0 mm (1.102 in.)

Minimum thickness :
25.0 mm (0.983 in.)



share

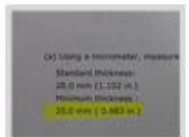
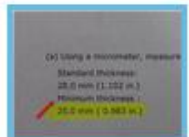

Vehicle Photo #2: Tire Replacement

Fontana Nissan

Fontana, CA

<http://www.fontananissan.com/photos.php>





✕

Tire Replacement

YOUR CAR ILLUSTRATION TEXT IMAGE

➔

share

⬅➔

Tire Replacement

YOUR CAR ILLUSTRATION TEXT IMAGE

Tire tread

Steering & suspension systems

Perfect condition



Good condition



Poor condition



Underinflation



Overinflation



Failed strut or shock



Vehicle Photo #3: Oil Filter

BMW of Schererville

Schererville, IN

http://www.bmwinschererville.com/page/custom/en/Live_Repair_Orders

(We support this dealer through our partners at Dealer e-Process)

Oil Filter

YOUR CAR ILLUSTRATION TEXT IMAGE



share





Oil Filter

YOUR CAR ILLUSTRATION TEXT IMAGE

Oil filter
Engine

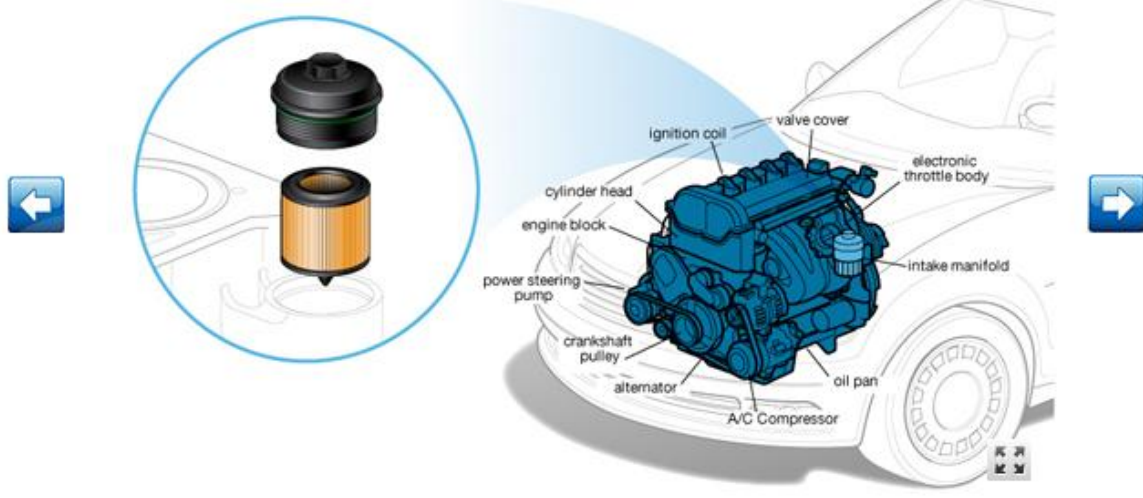

share



Vehicle Photo #4: Exhaust Pipe

Piercey Toyota

Milpitas, CA

<http://www.pierceytoyota.com/CIMPhotos.htm>

(We support this dealer through our partners at CIMA Systems)

Exhaust Pipe

YOUR CAR ILLUSTRATION TEXT IMAGE



share

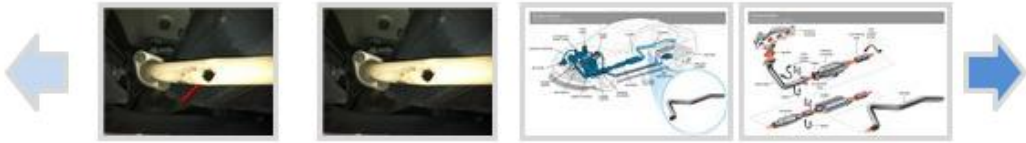



Exhaust Pipe

YOUR CAR ILLUSTRATION TEXT IMAGE

Exhaust tail pipe
Exhaust & emissions system

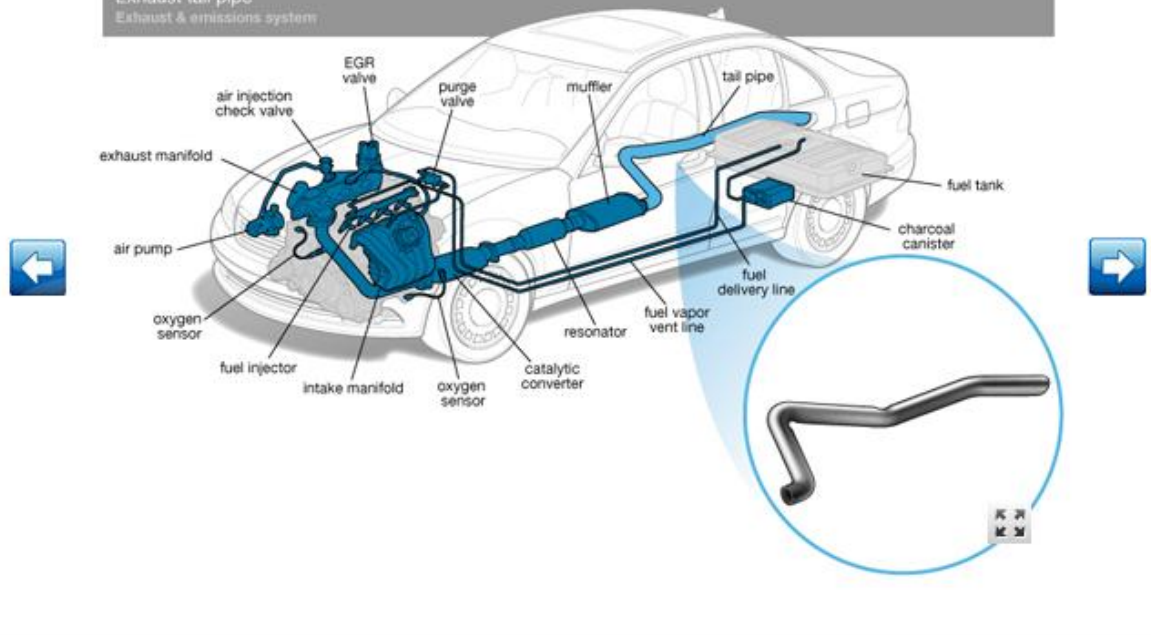

share

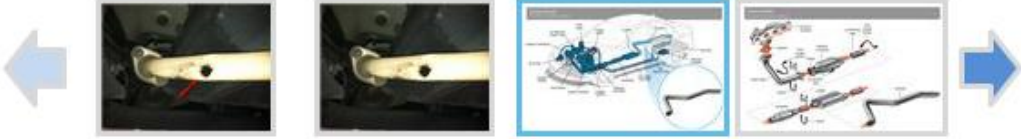

Vehicle Photo #5: Rack

Heyward Allen Toyota

Athens, GA

<http://www.heywardallentoyota.com/service/clear-mechanic.htm>

Rack

YOUR CAR ILLUSTRATION TEXT



share





Rack

YOUR CAR ILLUSTRATION TEXT

Rack
Suspension & Steering systems

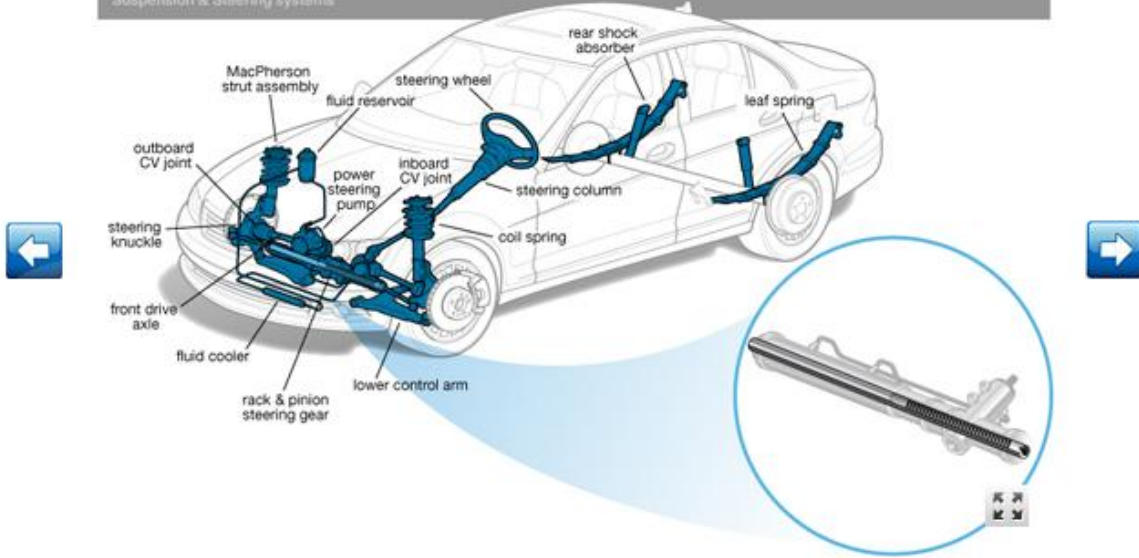

share

